

UL-Listed Split-Core CT SCT-0250-030

0.25 inch Opening with Rating of 30 Amps

Magnelab's new UL-Listed SCT-0250-030 split-core sensor measures AC current up to 30 Amps. The SCT-0250-030 meets IEC 61869-2 Class 0.5 and is UL-Listed according to UL 2808. The SCT-0250-030 is compact, performs well and is easy to install around existing conductors.



SPECIFICATIONS

Rated Primary Current	30 A
Rated Output	333 mV
Weight	0.22 lbs (100 g)
Phase Displacement	< 0.5° at full-scale
Temperature Rating	Operating: -40 to 185°F (-40° to 85°C) Storage: -49° to 194°F (-45°C to 90°C)
Leads	8 ft. 18 AWG black/white cable Rating: 600V (UL 2808)
Insulation Voltage	3510 VAC Insulation Test (1 min)
Rated Frequency	50 - 400 Hz
Pollution Degree	Degree 2, up to 2000 meters
Certifications	UL 2808 Listed; IEC 61010-1
Accuracy	0.5 Class

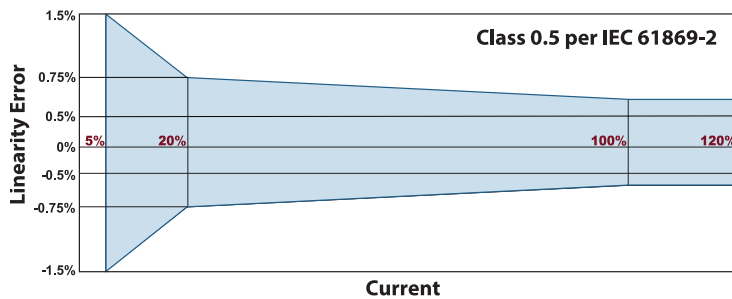

APPLICATIONS

- Energy and sub-metering
- Electrical load monitoring
- Network equipment
- Instruments and sensors
- Control systems
- Solar and renewable energy

PRODUCT DIMENSIONS

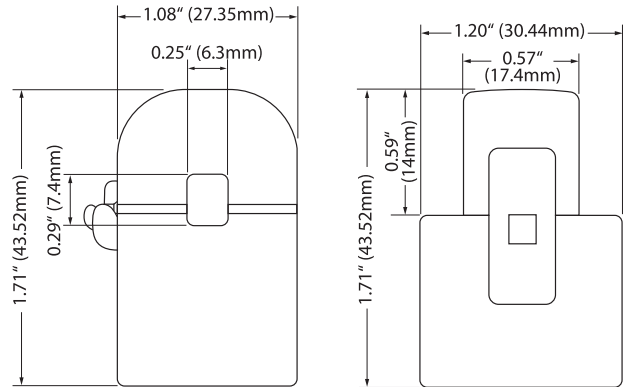

SCHEMATIC

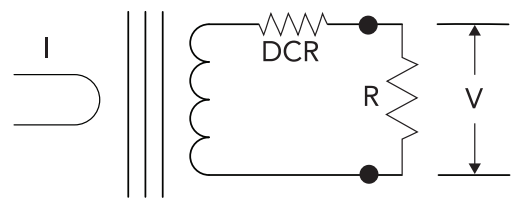

UL-LISTED SCT SERIES

PRODUCT #	WINDOW SIZE	INPUT RATING
SCT-0250-030	0.25" (6.3mm)	30 A
SCT-0450-050	0.47" (12mm)	50 A
SCT-0950-200	0.95" (24mm)	200 A

